

0.098" (2.50 mm) Pitch Disconnectable Connectors

3001 Series

SPECIFICATION

Poles: 2-16
 Voltage rating: AC, DC 250V
 Current rating: AC, DC, 1A
 Withstand voltage: 1000V AC/min.
 Insulation resistance: 1000M Ω /min.
 Temperature range: -20°C ~ +85°C
 Applicable PC board thickness: 0.031" ~ 0.063" (0.8~1.6mm)
 Contact resistance: Initial value/10m Ω max.
 After environmental testing/20m Ω max.

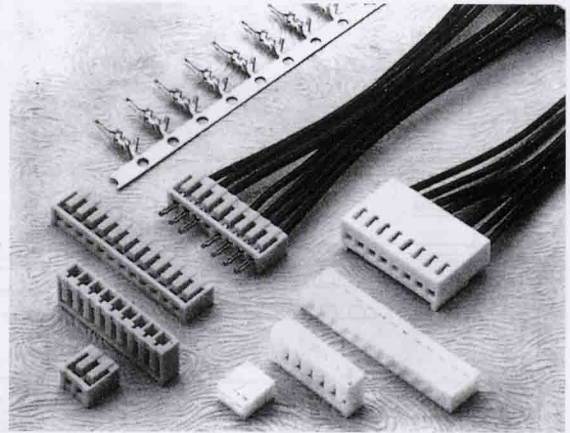

TERMINAL

Part No: 3001TS(180°)
 Applicable wires: AWG#22-30
 Material: Phos. Bronze (Brass)
 Finish: Tin/plated
 Hardness: H
 Thickness: 0.2mm

TERMINAL 3001T(180°)

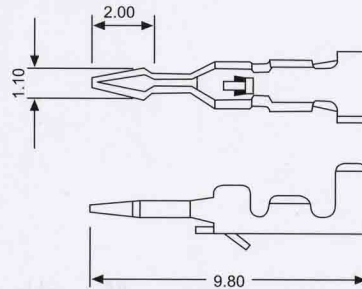

HOUSING

Part No: 3001HS(180°)
 Poles: 2-16
 Material: Nylon 66, UL 94V-0

HOUSING 3001H(180°)

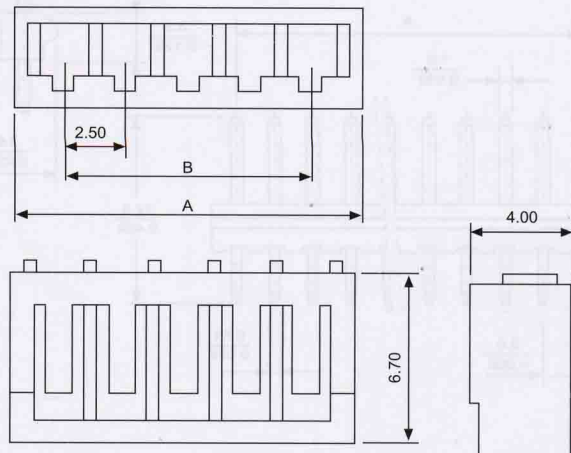

Dimension: mm

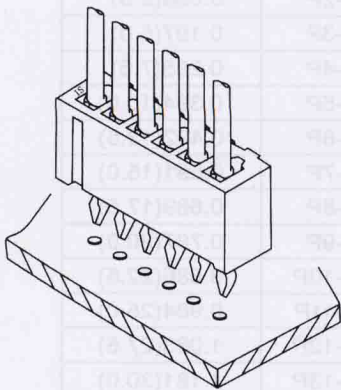

POLES	PART NO.	Dimension in.(mm)		POLES	PART NO.	Dimension in.(mm)	
		A	B			A	B
2	3001HS-2P	6.60	2.50	12	3001HS-12P	31.60	27.50
3	3001HS-3P	9.10	5.00	13	3001HS-13P	34.10	30.00
4	3001HS-4P	11.60	7.50	14	3001HS-14P	36.60	32.50
5	3001HS-5P	14.10	10.00	15	3001HS-15P	39.10	35.00
6	3001HS-6P	16.60	12.50	16	3001HS-16P	41.60	37.50
7	3001HS-7P	19.10	15.00	17	3001HS-17P	44.10	40.00
8	3001HS-8P	21.60	17.50	18	3001HS-18P	46.60	42.50
9	3001HS-9P	24.10	20.00	19	3001HS-19P	49.10	45.00
10	3001HS-10P	26.60	22.50	20	3001HS-20P	54.60	47.50
11	3001HS-11P	29.10	25.00				

0.098" (2.50 mm) Pitch Disconnectable Connectors

3001 Series

SPECIFICATION

Poles:2-16
 Voltage rating: AC,DC 250V
 Current rating: AC,DC, 1A
 Withstand voltage:1000V AC/min.
 Insulation resistance:1000M Ω /min.
 Temperature range:-20°C~ +85°C
 Applicable PC board thickness:0.031 " ~0.063 " (0.8~1.6mm)
 Contact resistance:Initial value/10m Ω max.
 After environmental testing/20m Ω max.

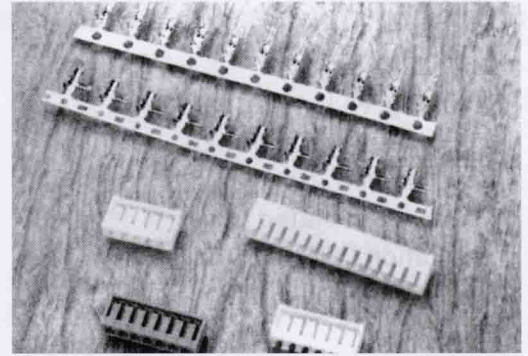

TERMINAL

Part No:3001TR(90°)
 Applicable wires:AWG#22-30
 Material:Phos.Bronze(Brass)
 Finish:Tin/plated
 Hardness:H
 Thickness:0.2mm

TERMINAL 3001TR(90°)

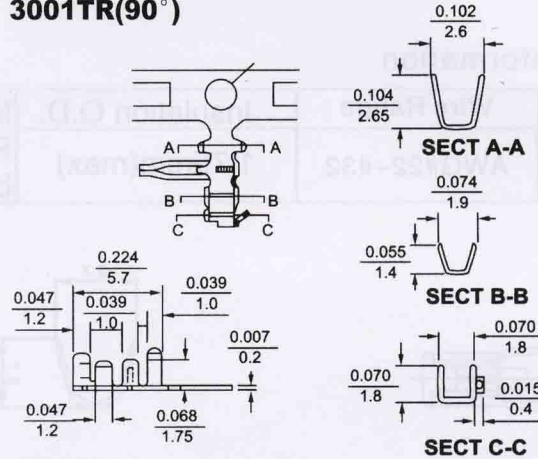

HOUSING

Part No:3001HR
 Poles:2-16
 Material:Nylon 66,UL 94V-0

HOUSING 3001HR(90°)

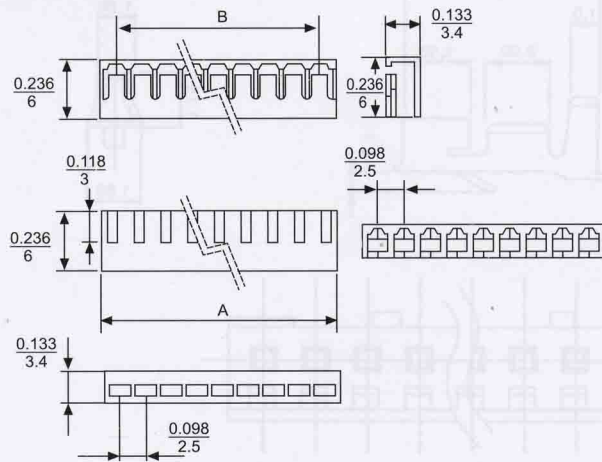

Dimension: $\frac{\text{Inch}}{\text{mm}}$

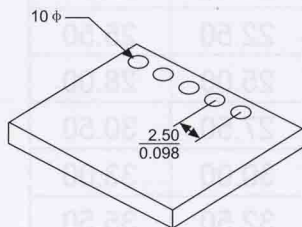
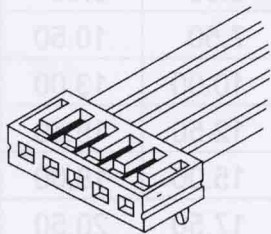

POLES	PART NO.	Dimension in.(mm)		POLES	PART NO.	Dimension in.(mm)	
		A	B			A	B
2	3001HR-2P	0.217(5.5)	0.098(2.5)	10	3001HR-10P	1.004(25.5)	0.886(22.5)
3	3001HR-3P	0.315(8.0)	0.197(5.0)	11	3001HR-11P	1.102(28.0)	0.984(25.0)
4	3001HR-4P	0.413(10.5)	0.295(7.5)	12	3001HR-12P	1.201(30.5)	1.083(27.5)
5	3001HR-5P	0.512(13.0)	0.394(10.0)	13	3001HR-13P	1.300(33.0)	1.181(30.0)
6	3001HR-6P	0.610(15.5)	0.492(12.5)	14	3001HR-14P	1.398(35.5)	1.280(32.5)
7	3001HR-7P	0.709(18.0)	0.591(15.0)	15	3001HR-15P	1.496(38.0)	1.378(35.0)
8	3001HR-8P	0.807(20.5)	0.689(17.5)	16	3001HR-16P	1.575(40.0)	1.476(37.5)
9	3001HR-9P	0.906(23.0)	0.787(20.0)				